

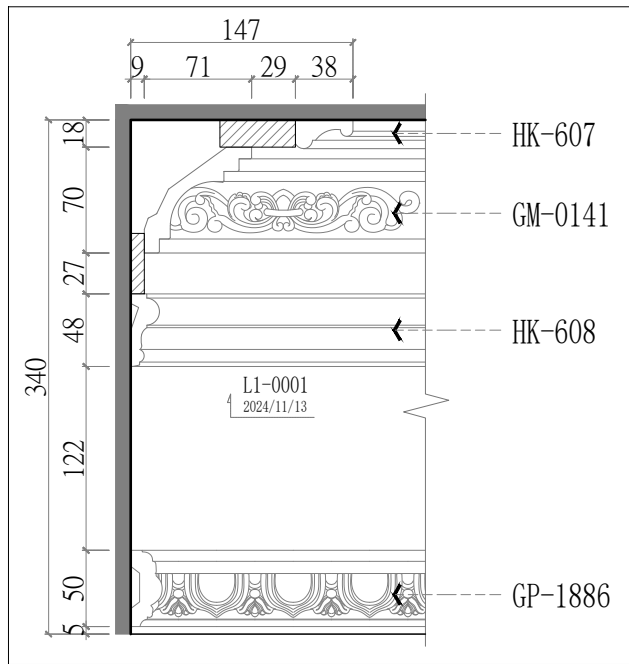

(A-0034)
平面配置圖
總坪數: 33.6坪

線板大樣圖	產品貨號表	線板大樣圖	產品貨號表
	GM-0141		HK-608
	GP-1886		HK-602
			HK-607



線板剖面圖



(A-0034)
天花板配置圖
總坪數: 33.6坪

圖樣	燈具名稱
	吊燈
	9mm嵌燈
	7mm嵌燈
	LED 鋁槽燈條

<天花板配置> (共1組)
飾花線板貨號與數量(1組)

L1	HK-607	9	pcs.
20.3M			
L2	GM-0141	9	pcs.
20.3M			
L3	HK-608	9	pcs.
20.3M			
L4	GP-1886	9	pcs.
20.3M			
L5	HK-602	8	pcs.
17.1M			
01	HK-602G	4	pcs.

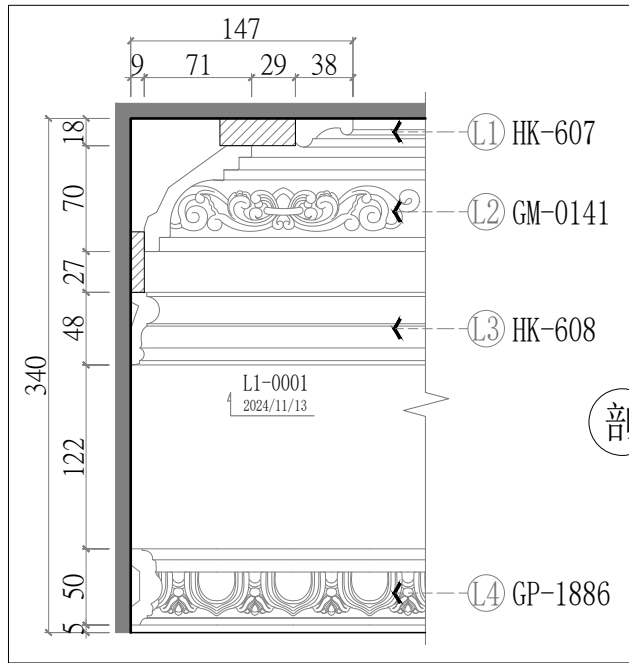





線板剖面圖



圖樣	燈具名稱
	吊燈
	9mm嵌燈
	7mm嵌燈
	LED 鋁槽燈條

(A-0034)
天花板配置 貨號表
總坪數: 33.6坪

線板大樣圖	產品貨號表
	HK-600
	HK-614
	SE-C94002
	W-1403

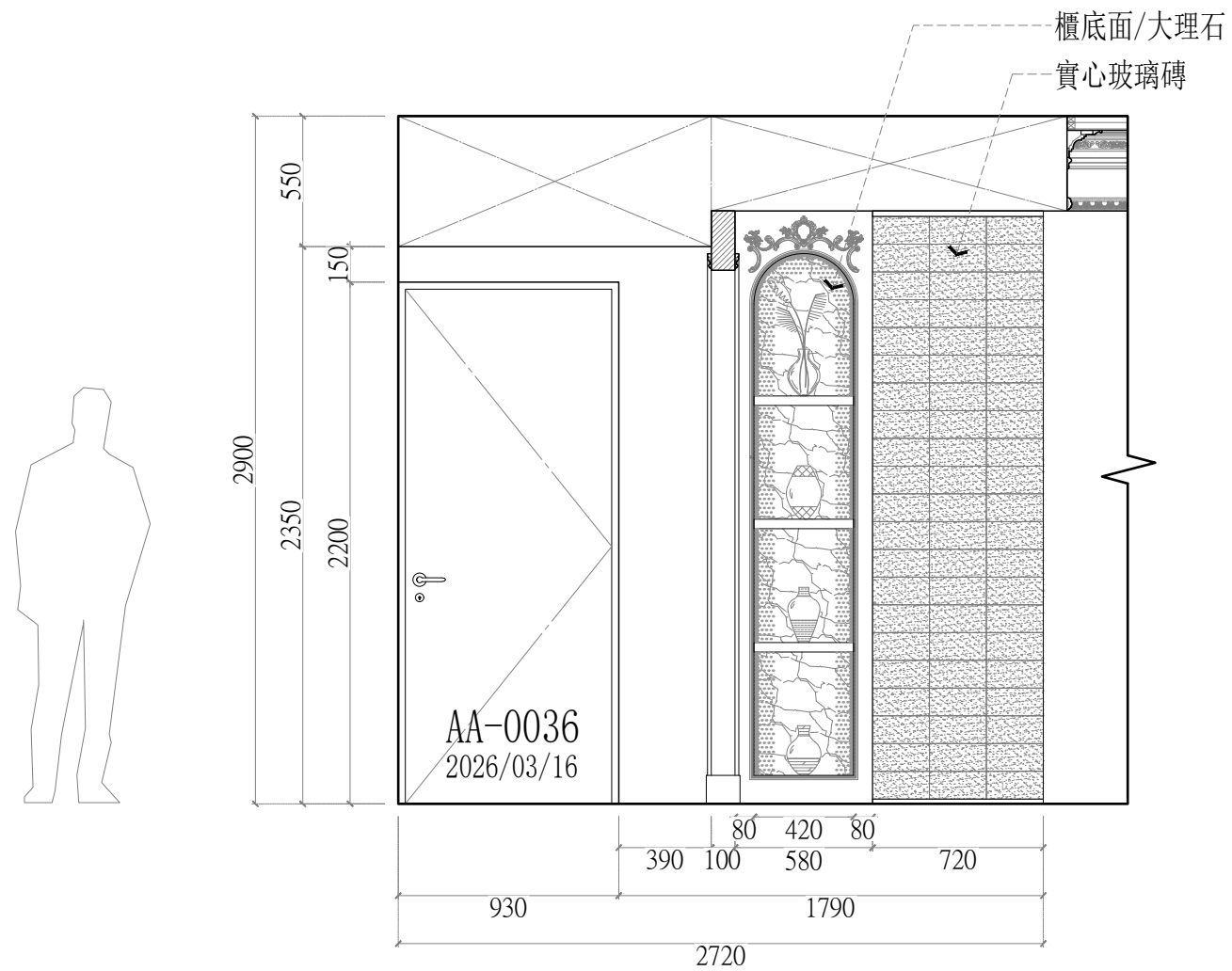
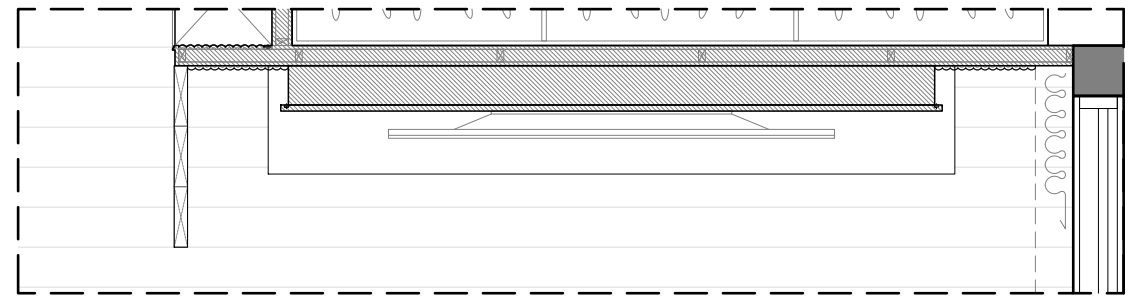
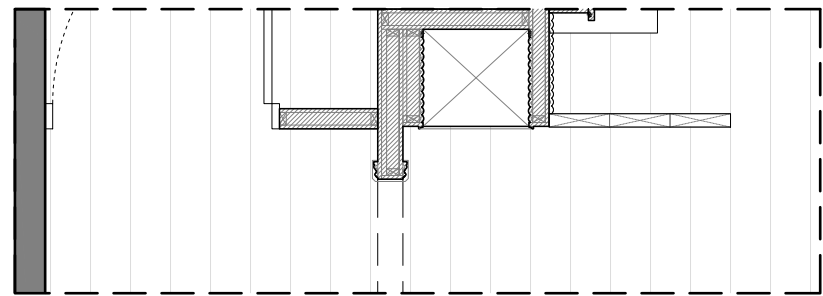

客廳 立面B-2配置圖

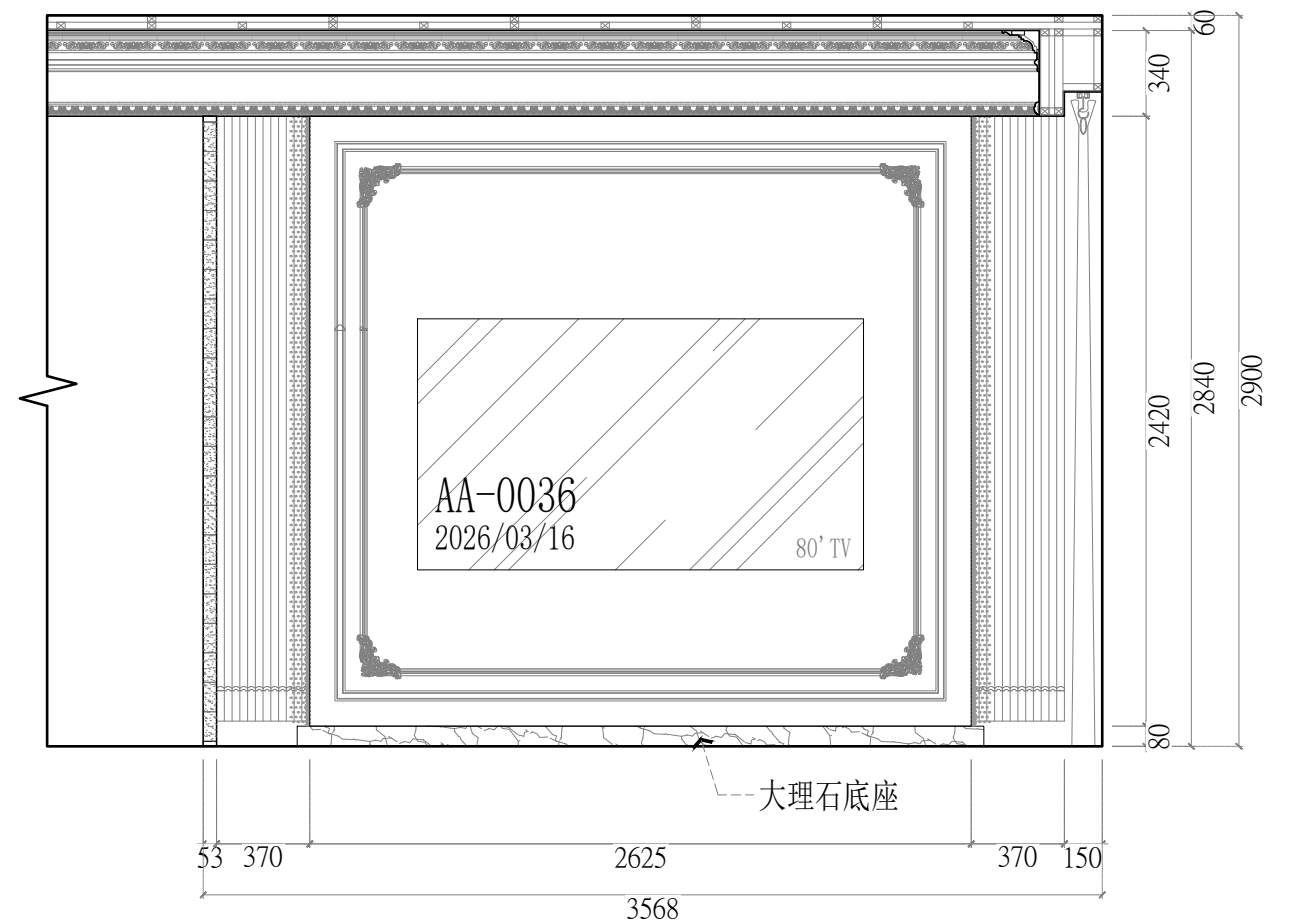

客廳 立面A-1配置圖

<立面A-1、B-2> (共1組) 飾花線板貨號與數量(1組)			
L1	HK-600	4	pcs.
	9.3M		
L2	HK-614	4	pcs.
	7.5M		
L3	W-1403	2	pcs.
	2.4M*2=4.8M		
L4	SE-C94002	3	pcs.
	5.2M		
01	HK-614G	4	pcs.

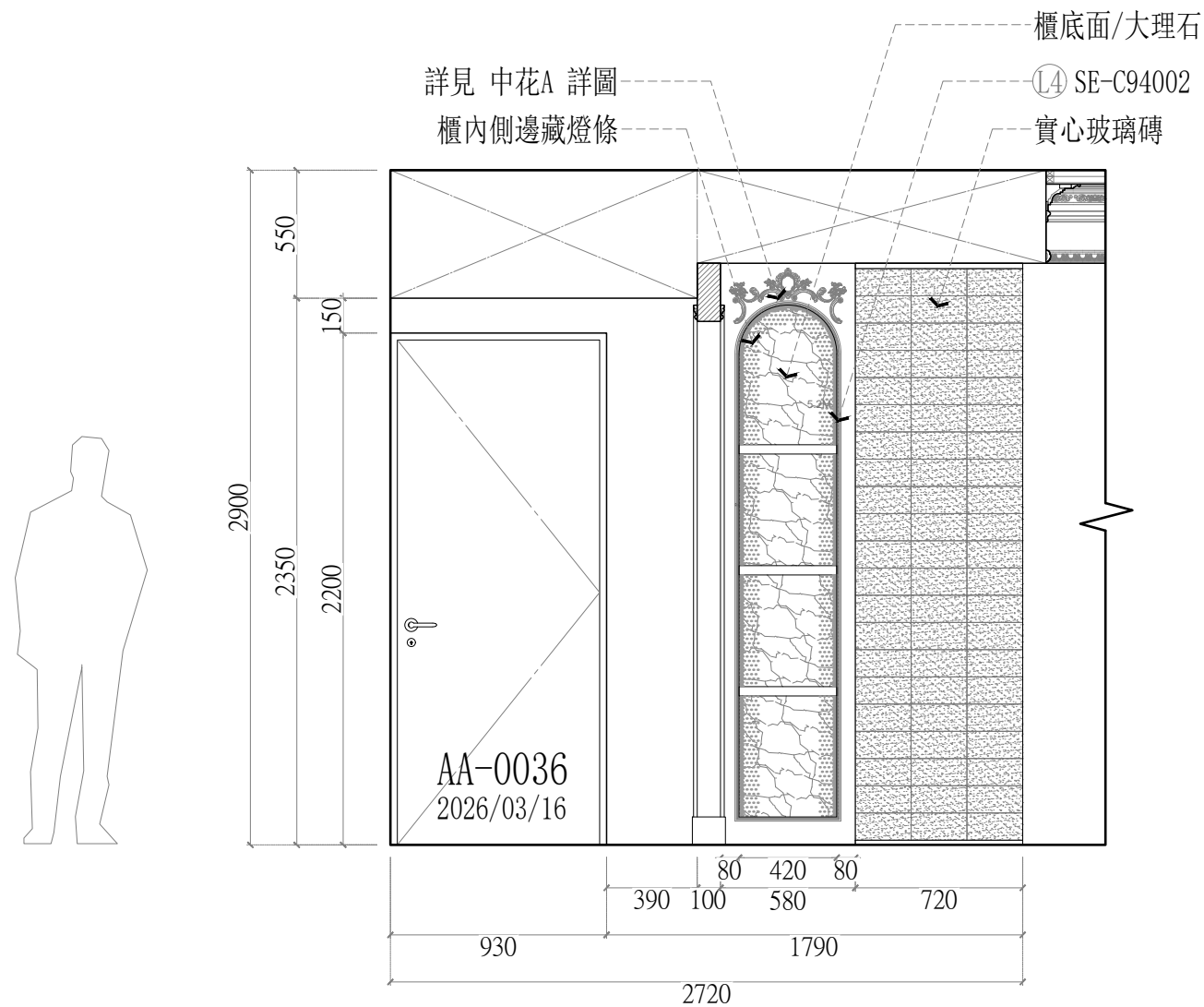
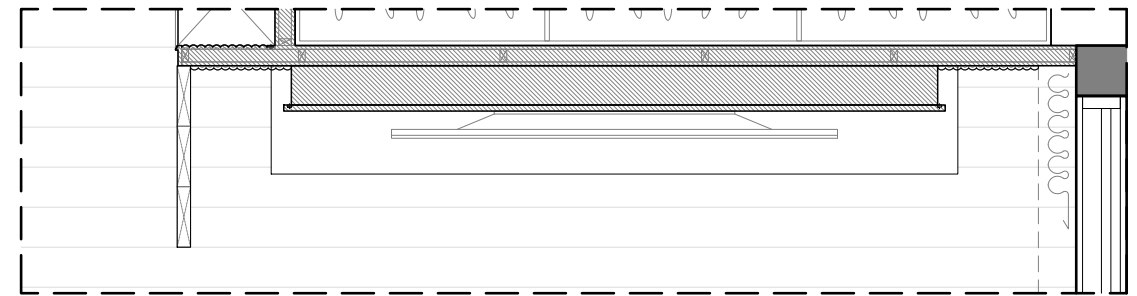
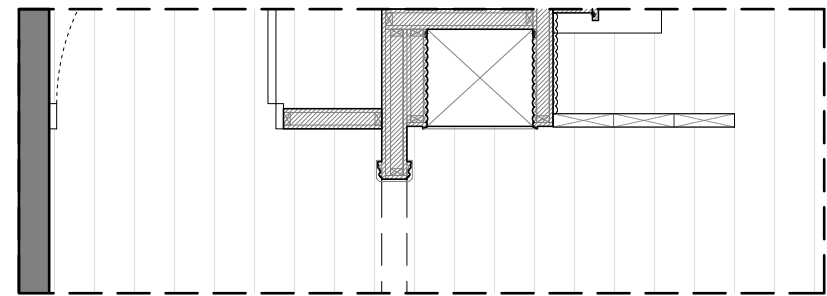

客廳 立面B-2配置圖

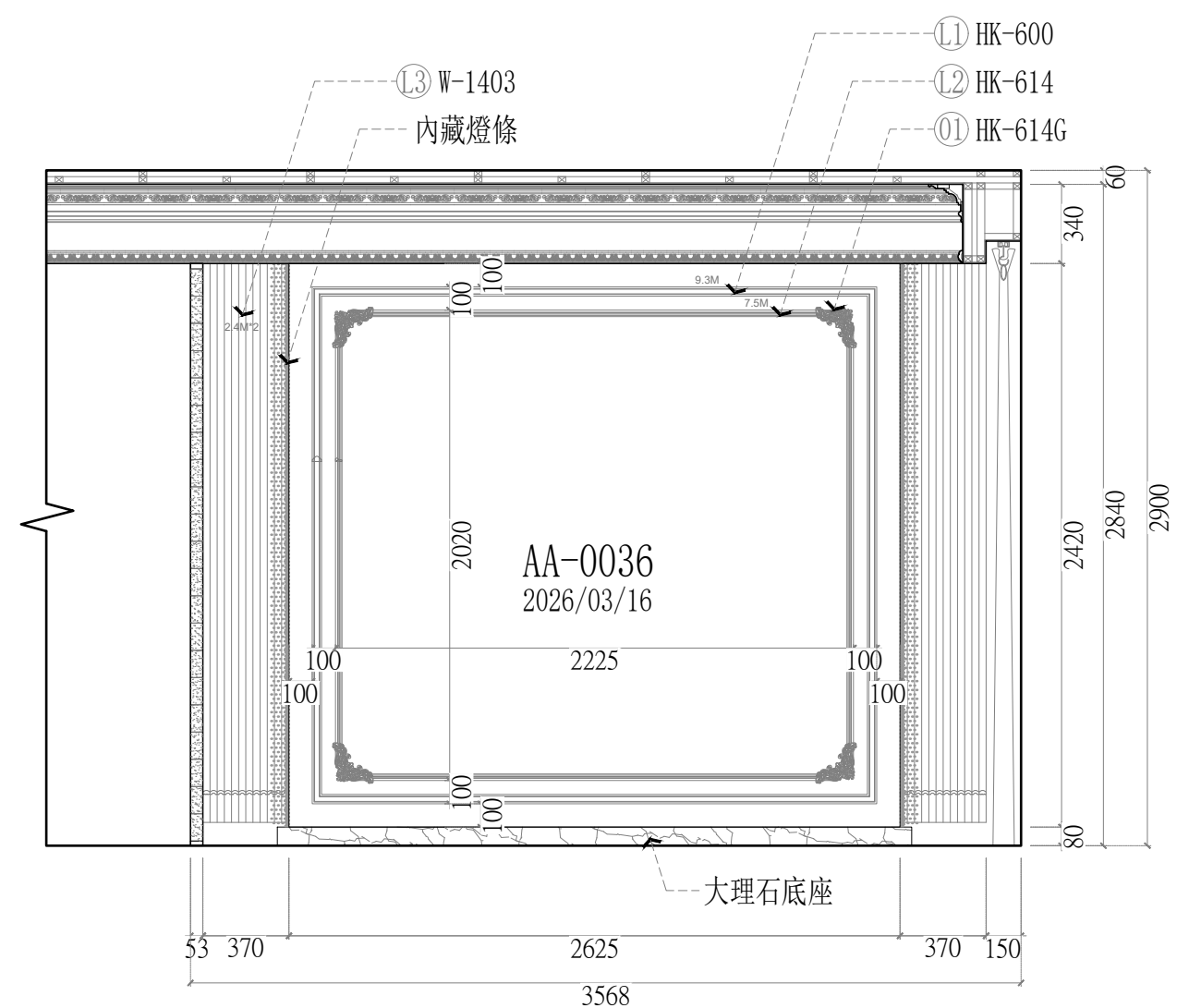

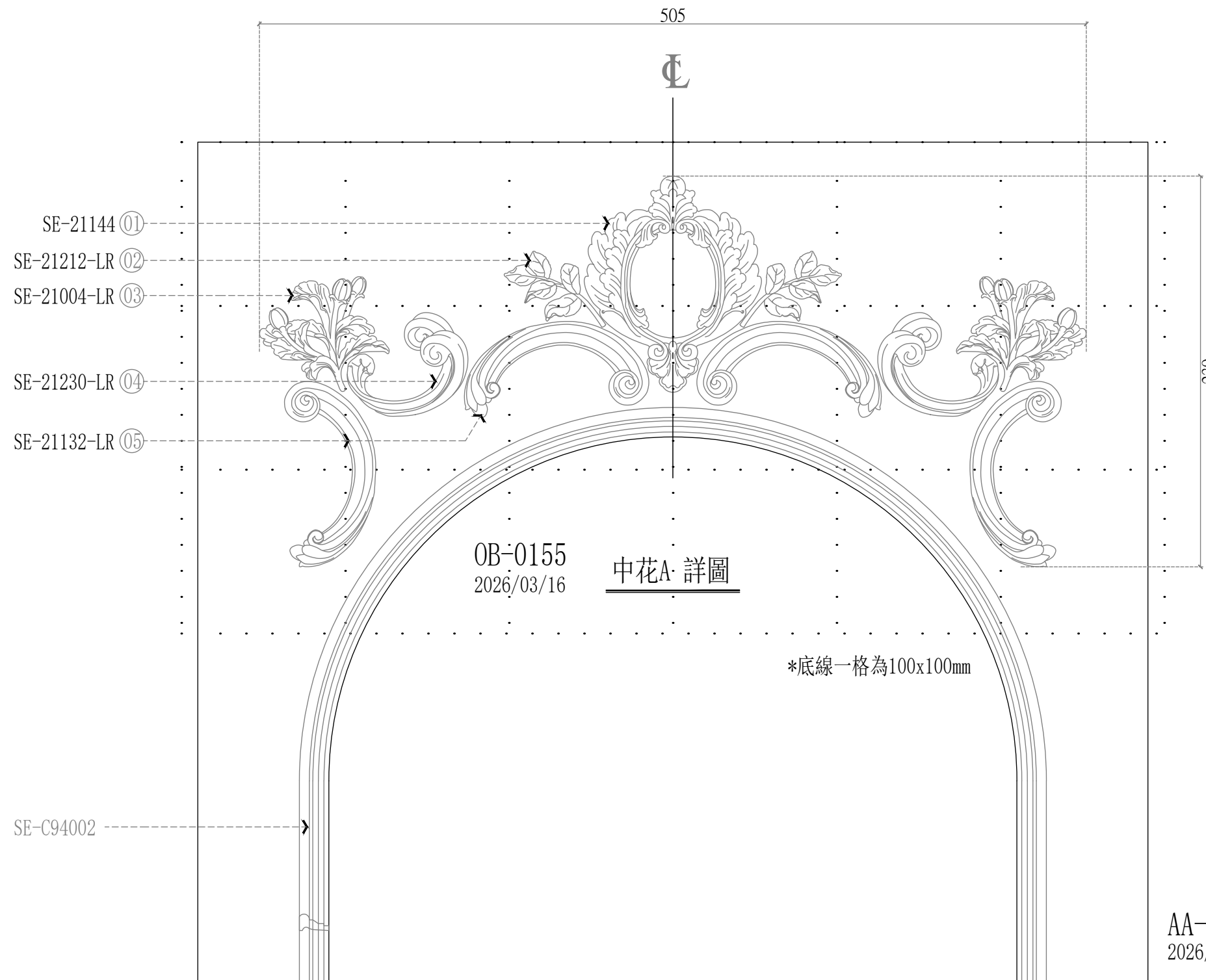

客廳 立面A-1配置圖



<中花A> (共1組)
飾花線板貨號與數量(1組)

01	SE-21144	1	pc.
02	SE-21212L	1	pc.
	SE-21212R	1	pc.
03	SE-21004L	1	pc.
	SE-21004R	1	pc.
04	SE-21230L	1	pc.
	SE-21230R	1	pc.
05	SE-21132L	2	pcs.
	SE-21132R	2	pcs.

AA-0036
2026/03/16

線板大樣圖	產品貨號表
	HK-600
	HK-614

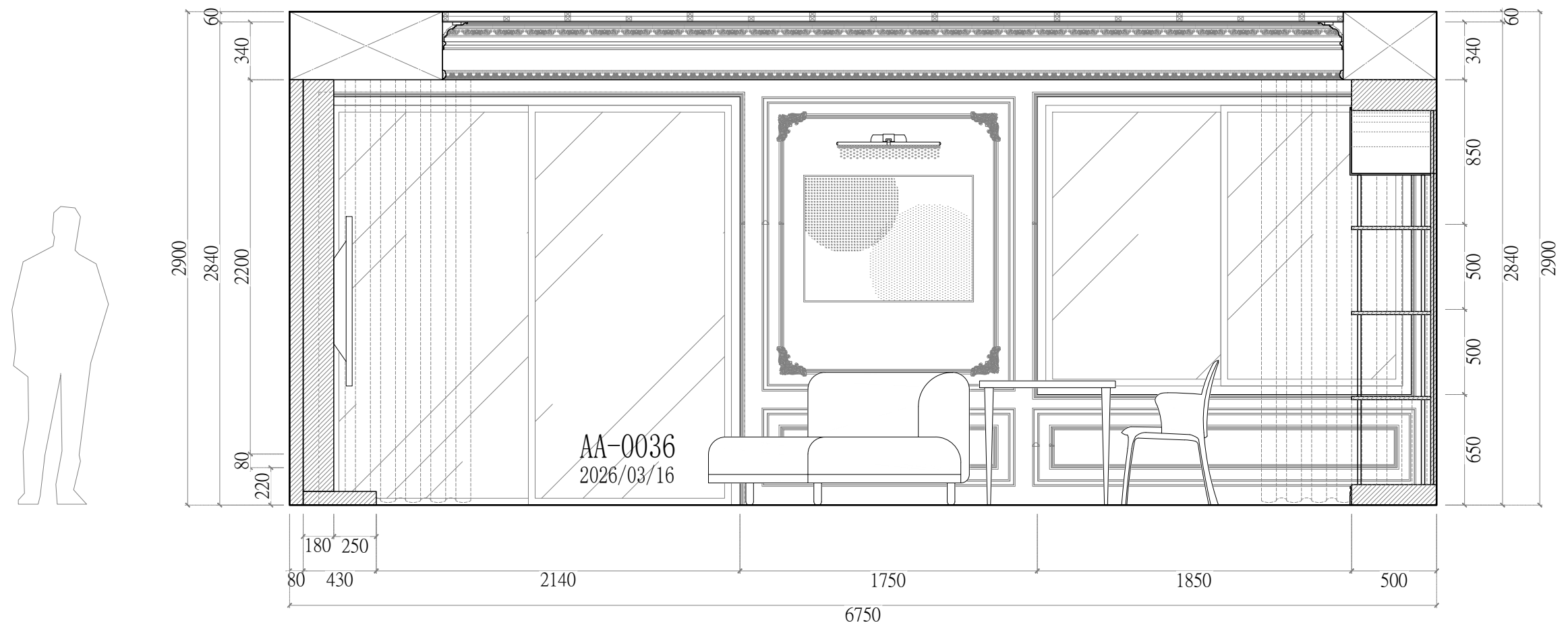
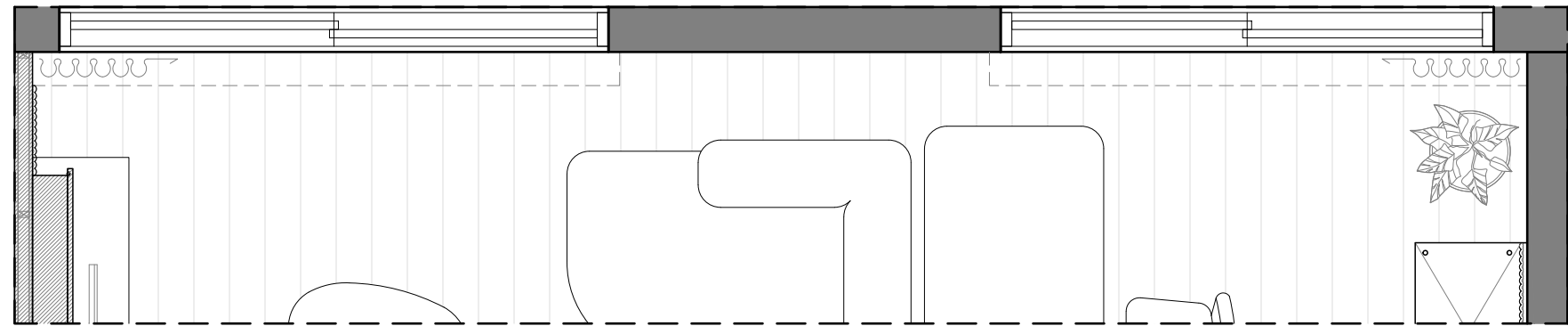





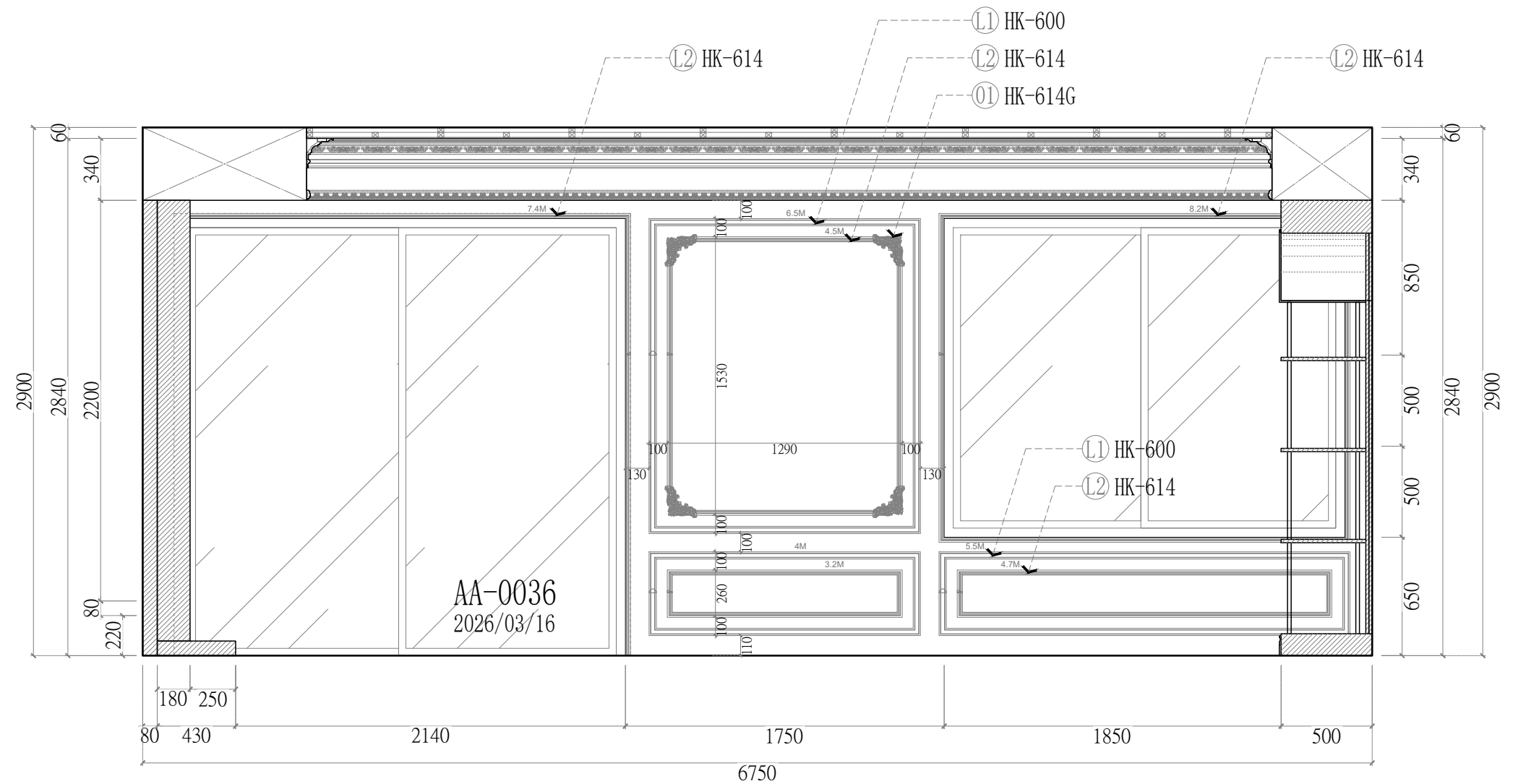
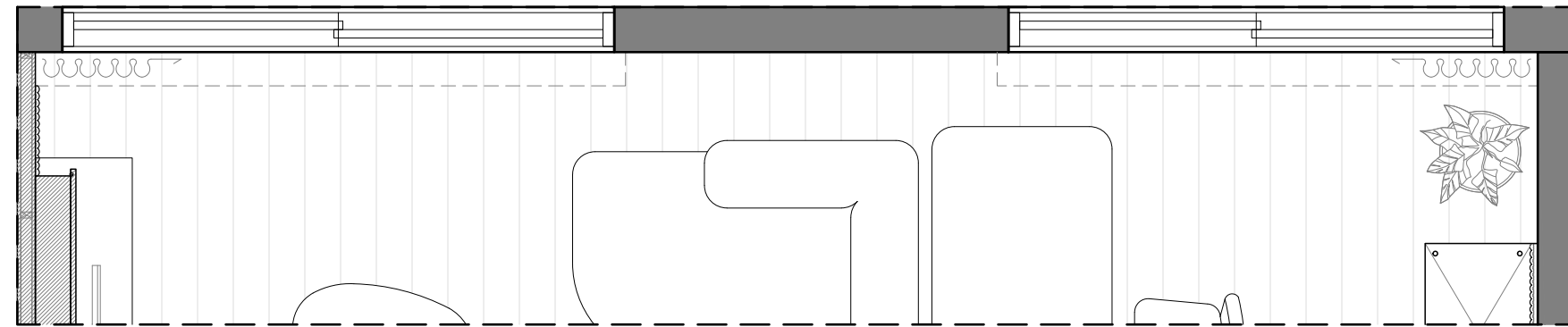

客廳 立面B-1配置圖

<立面B-1> (共1組) 飾花線板貨號與數量(1組)			
L1	HK-600	8	pcs.
	6.5M+4M+5.5M=16M		
L2	HK-614	13	pcs.
	4.5M+3.2M+4.7M+7.4M+8.2M=28M		
01	HK-614G	4	pcs.

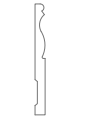

客廳立面B-1配置圖

線板大樣圖	產品貨號表	線板大樣圖	產品貨號表
	HK-600		HK-631D8
	HK-614		HK-0101
	SE-C94002		HK-957
	W-1403		

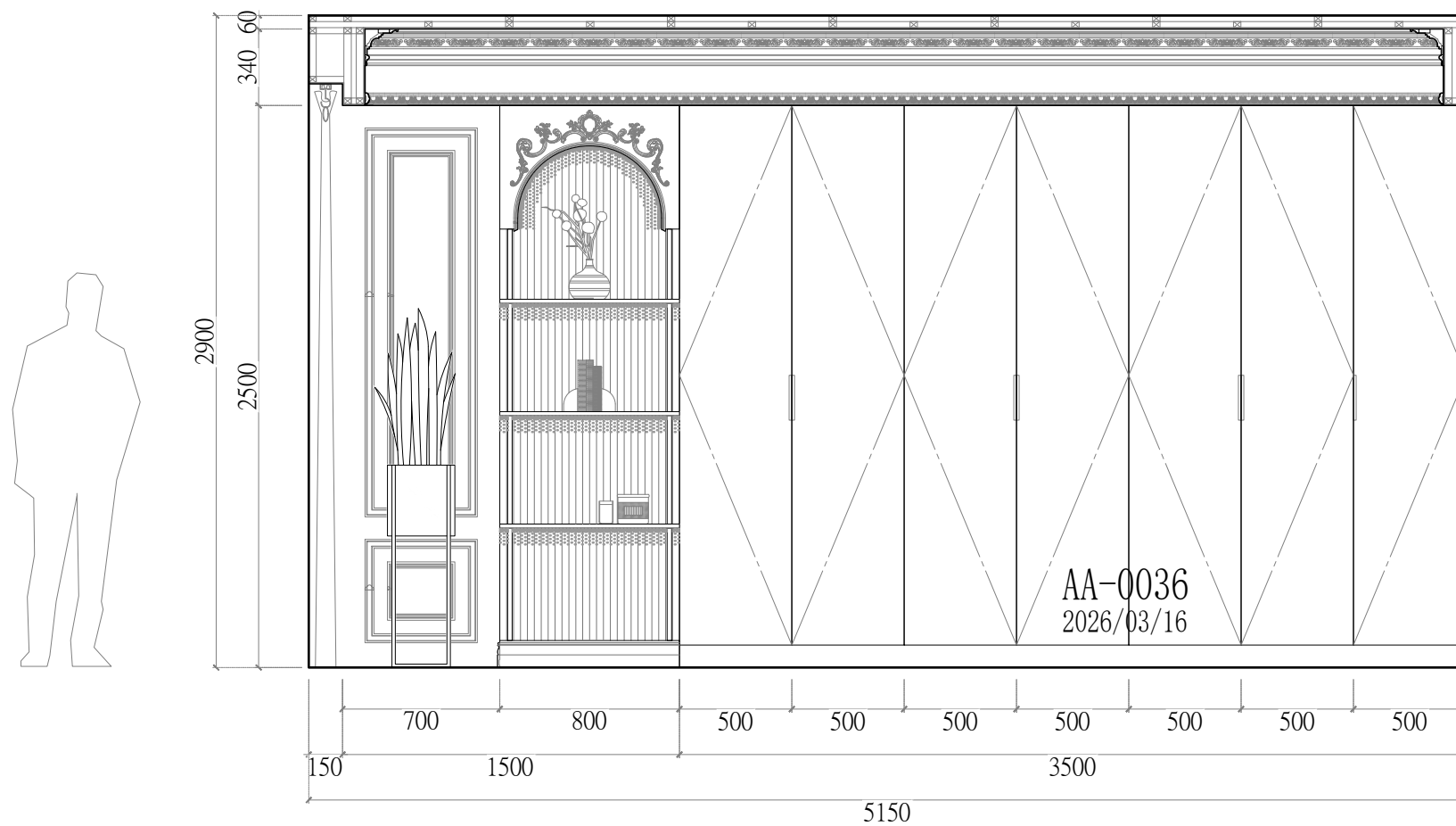
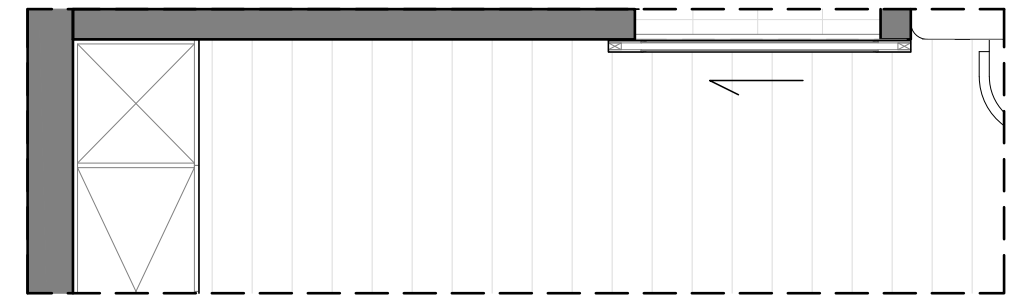
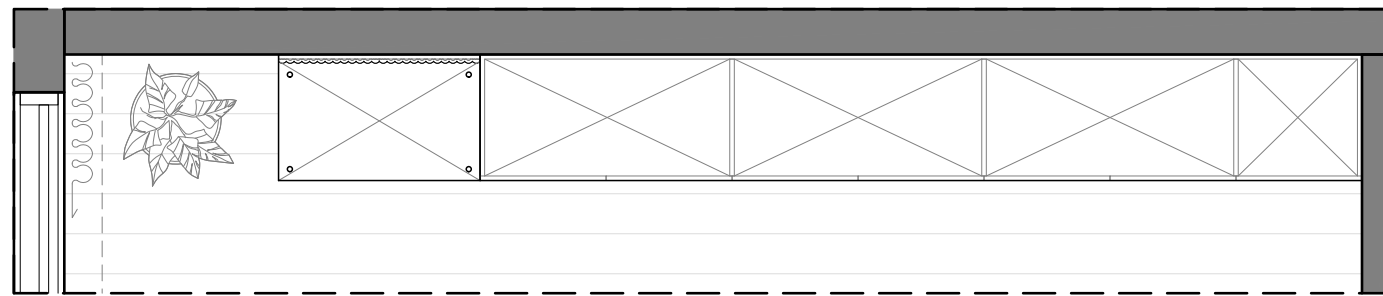

客廳 立面C-1配置圖

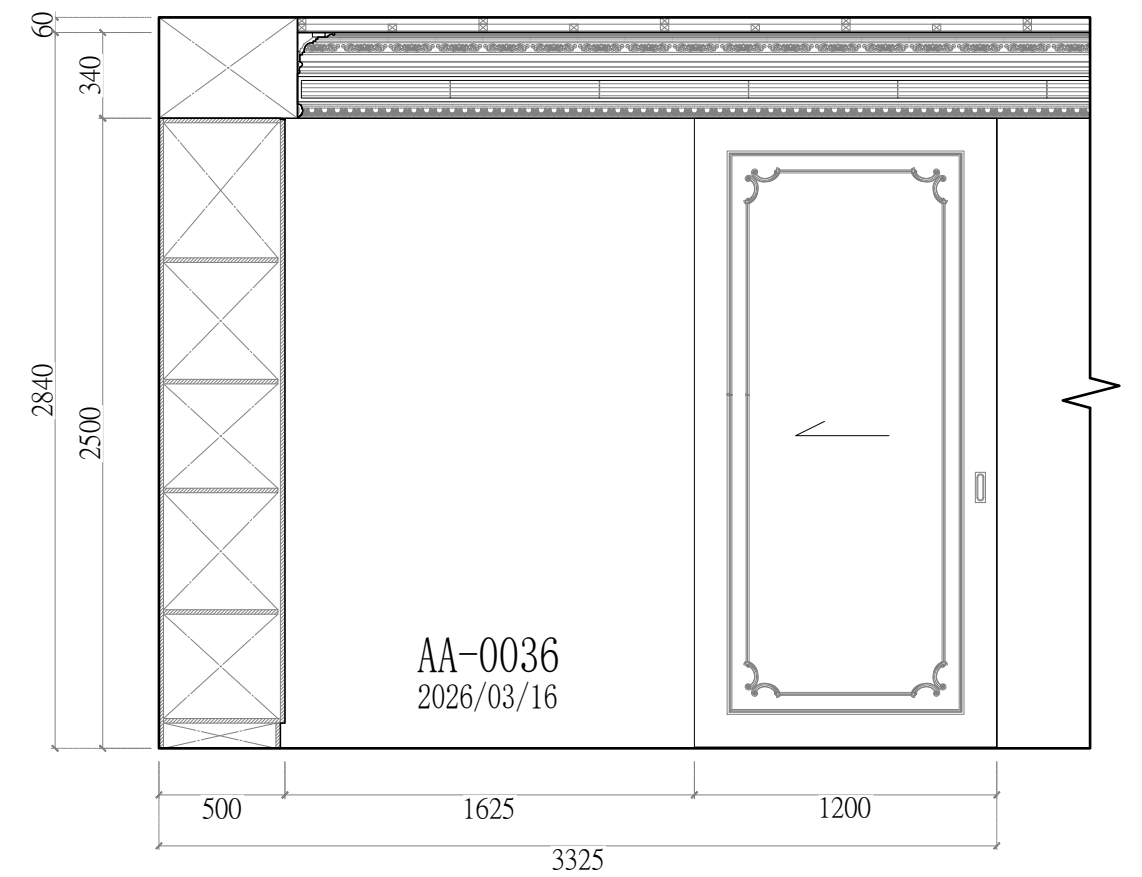

客廳 立面D-1配置圖

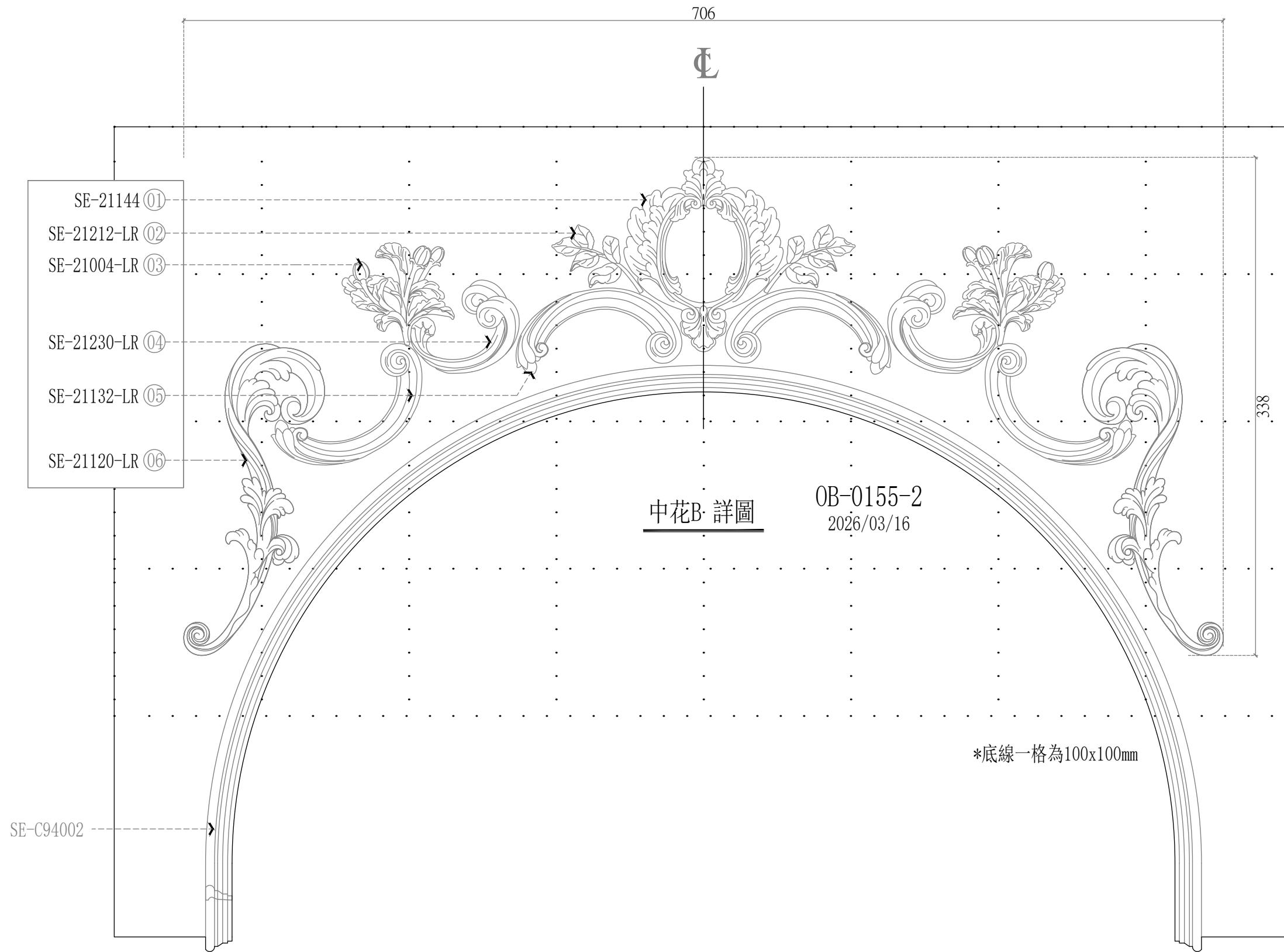



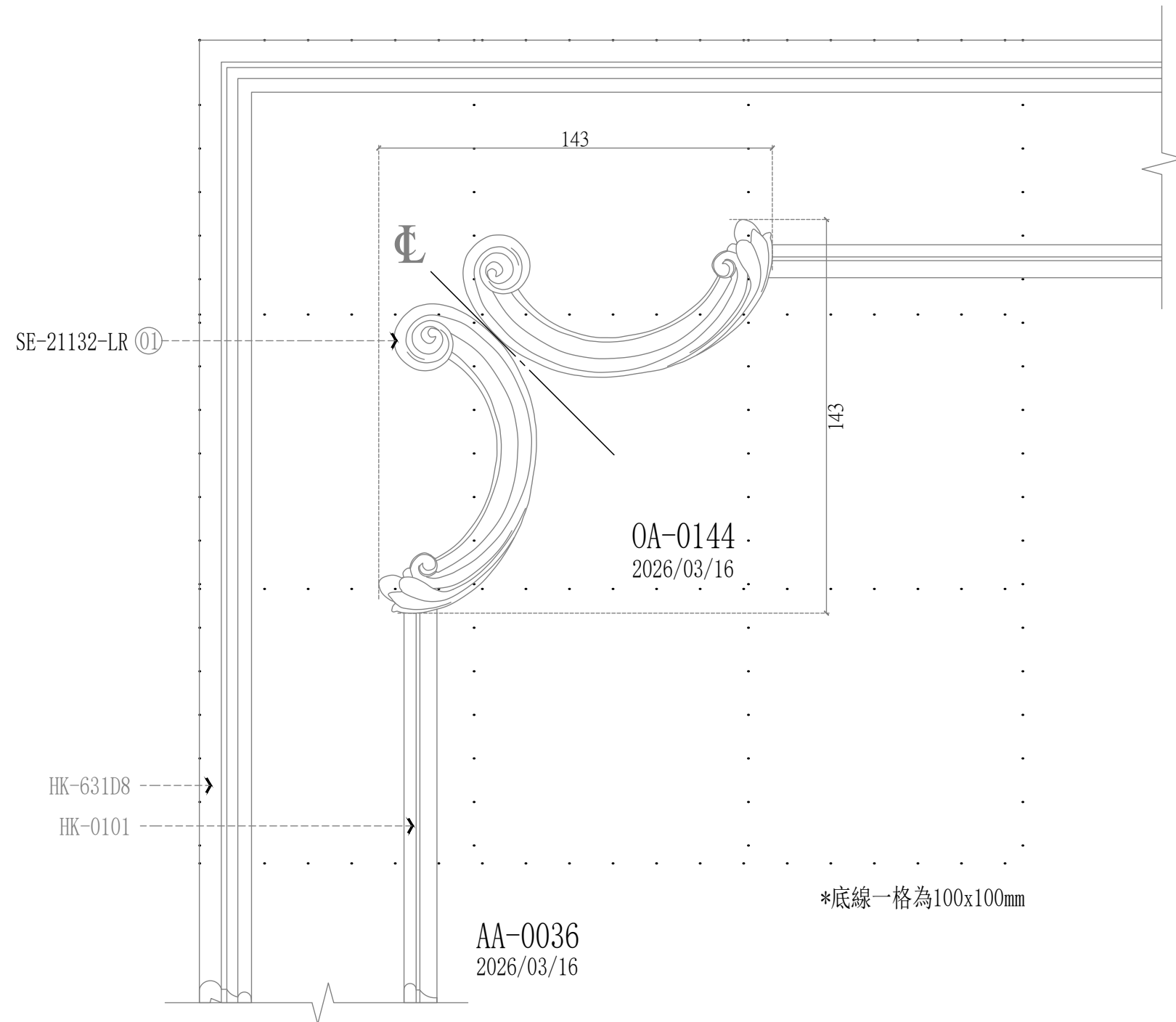

<中花B> (共1組)
飾花線板貨號與數量(1組)

01	SE-21144	1	pc.
02	SE-21212L	1	pc.
	SE-21212R	1	pc.
03	SE-21004L	1	pc.
	SE-21004R	1	pc.
04	SE-21230L	1	pc.
	SE-21230R	1	pc.
05	SE-21132L	2	pcs.
	SE-21132R	2	pcs.
06	SE-21120L	1	pc.
	SE-21120R	1	pc.

AA-0036
2026/03/16



<角花> (共8組) 飾花線板貨號與數量(1組)			
02	SE-21132L	1	pc.
	SE-21132R	1	pc.

線板大樣圖	產品貨號表
	HK-600
	HK-614
	HK-631D8
	HK-0101
	W-1407

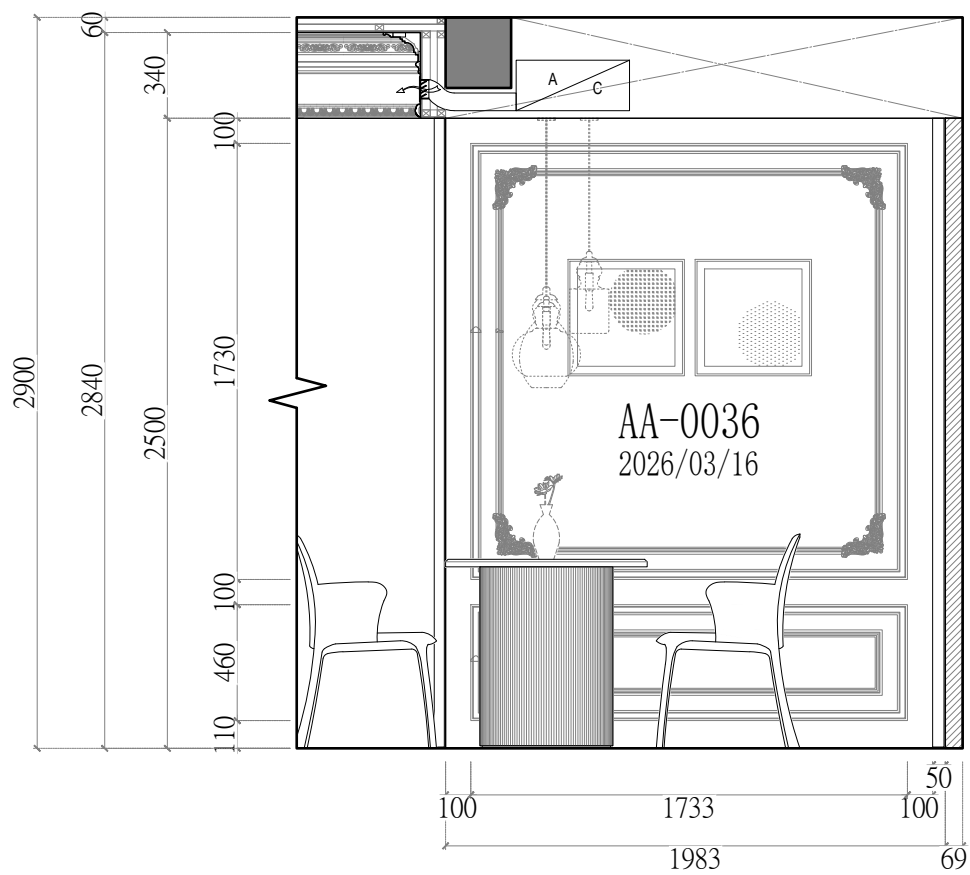
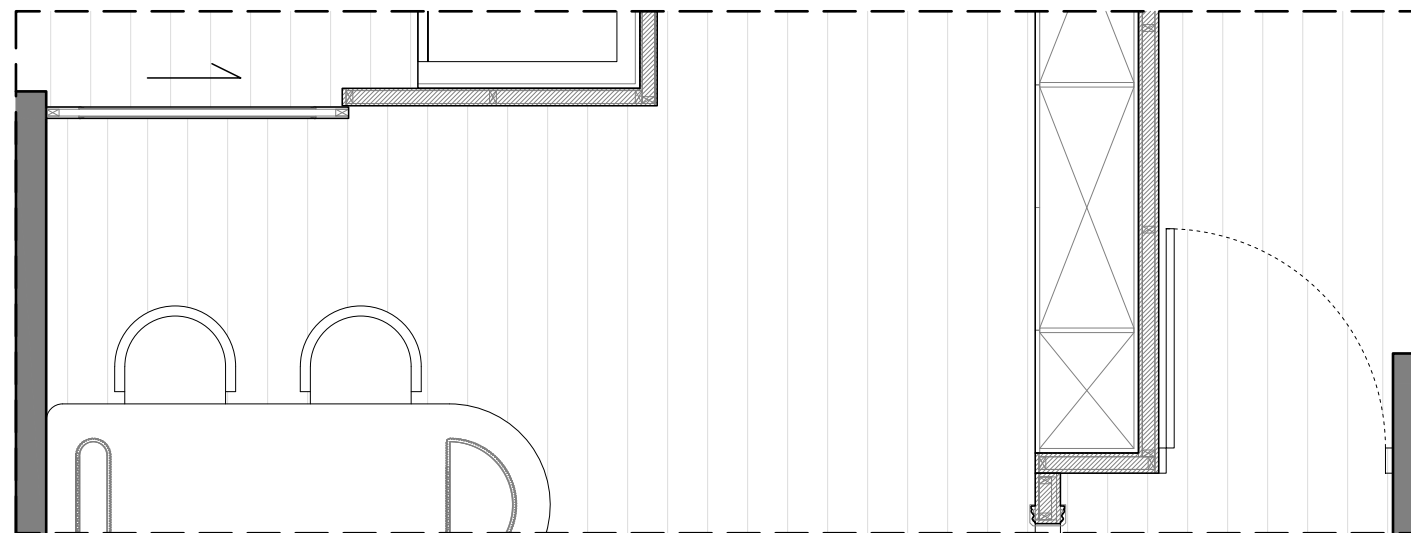
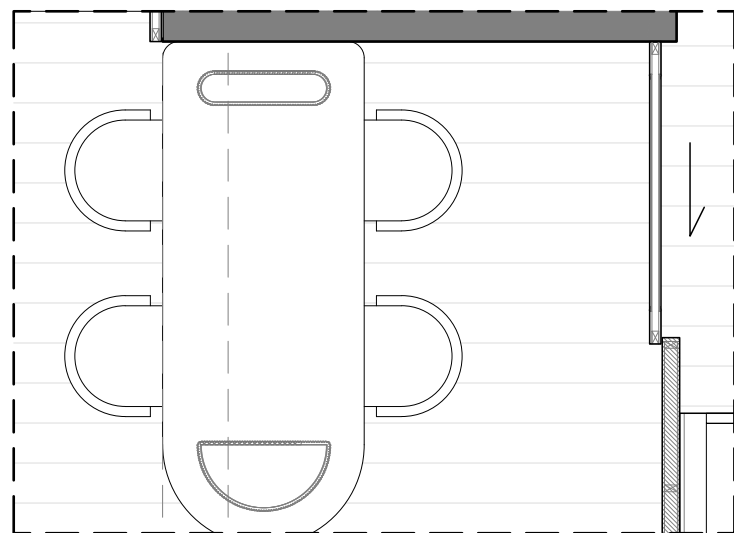

客廳 立面C-2配置圖

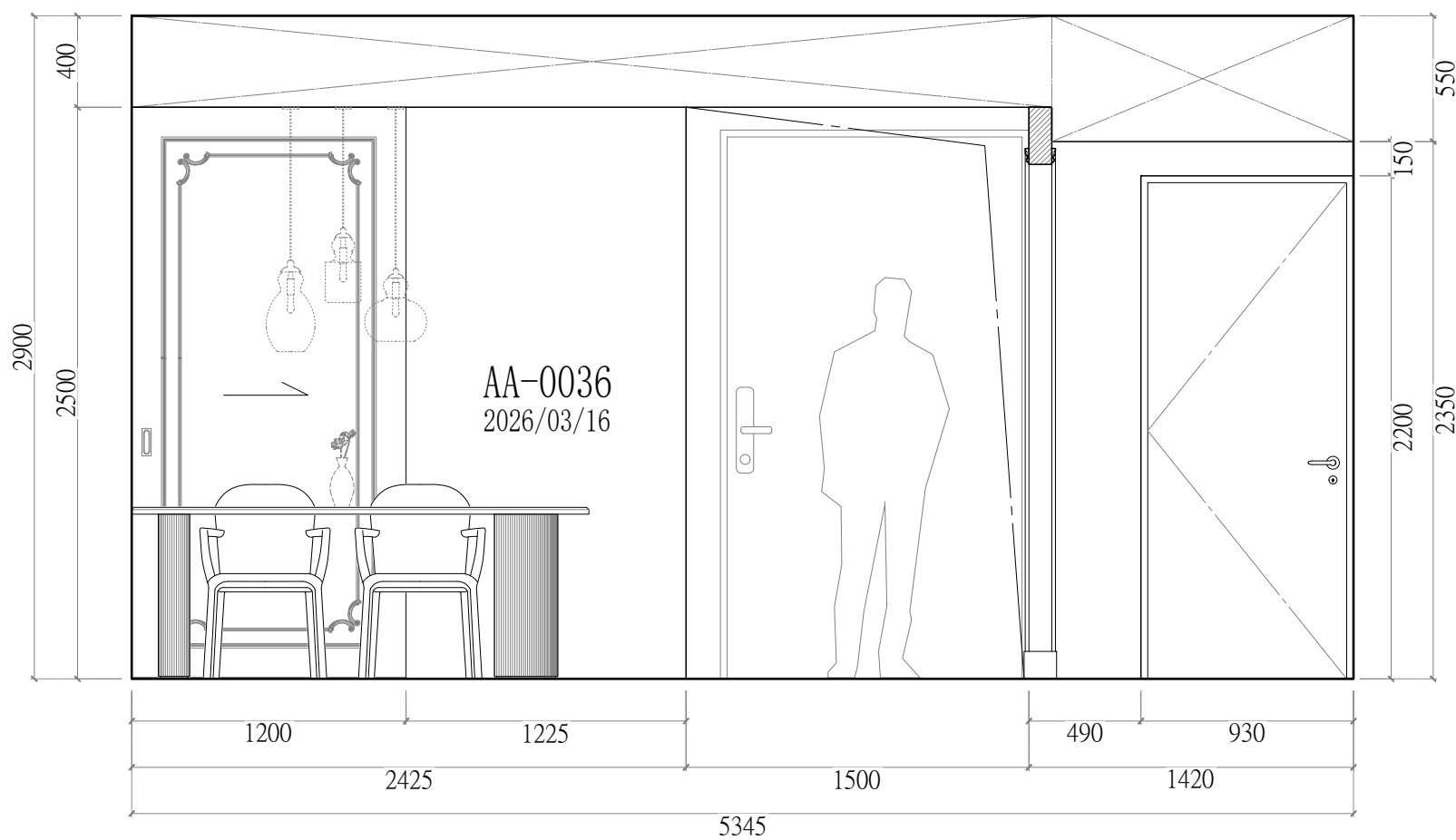

客廳 立面D-2配置圖

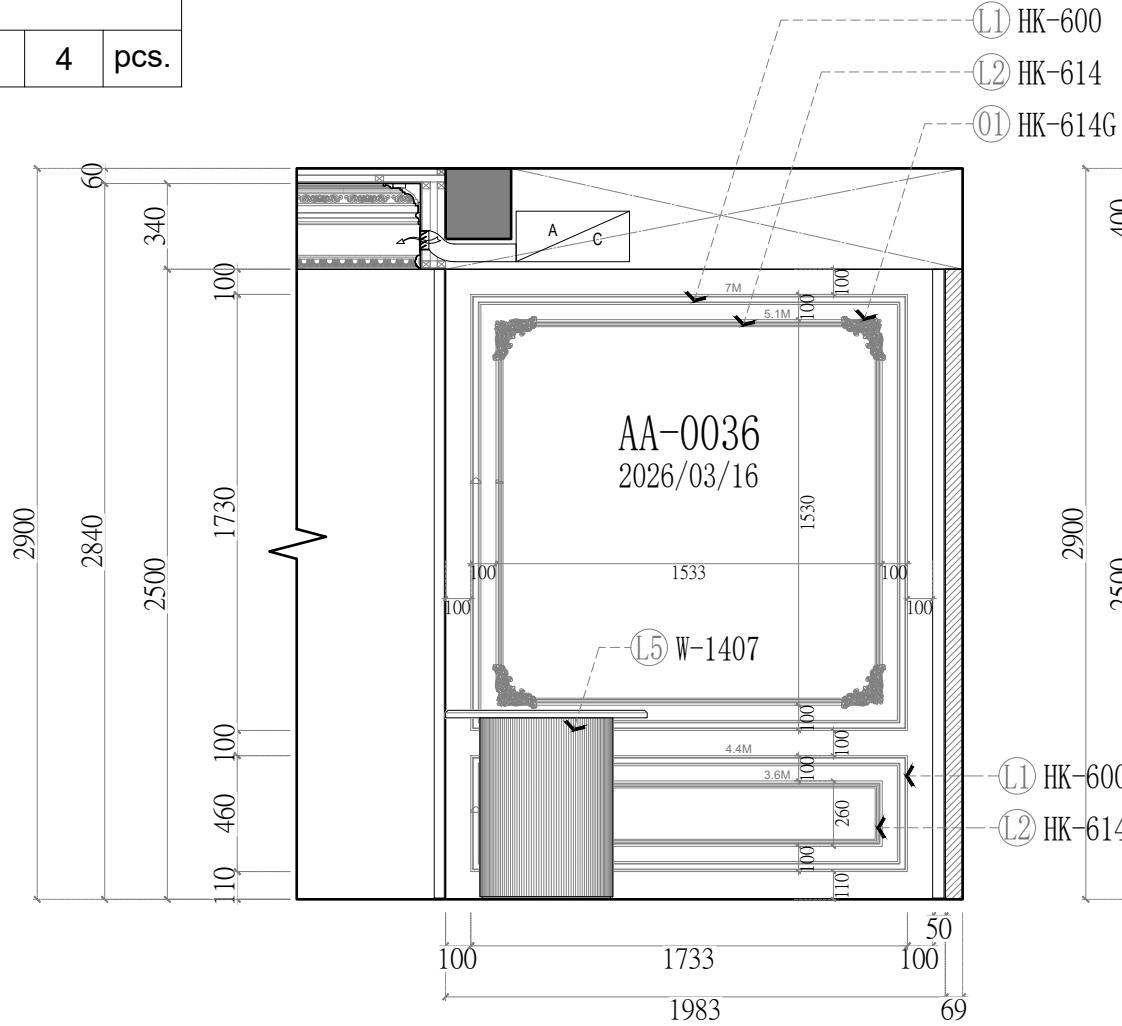
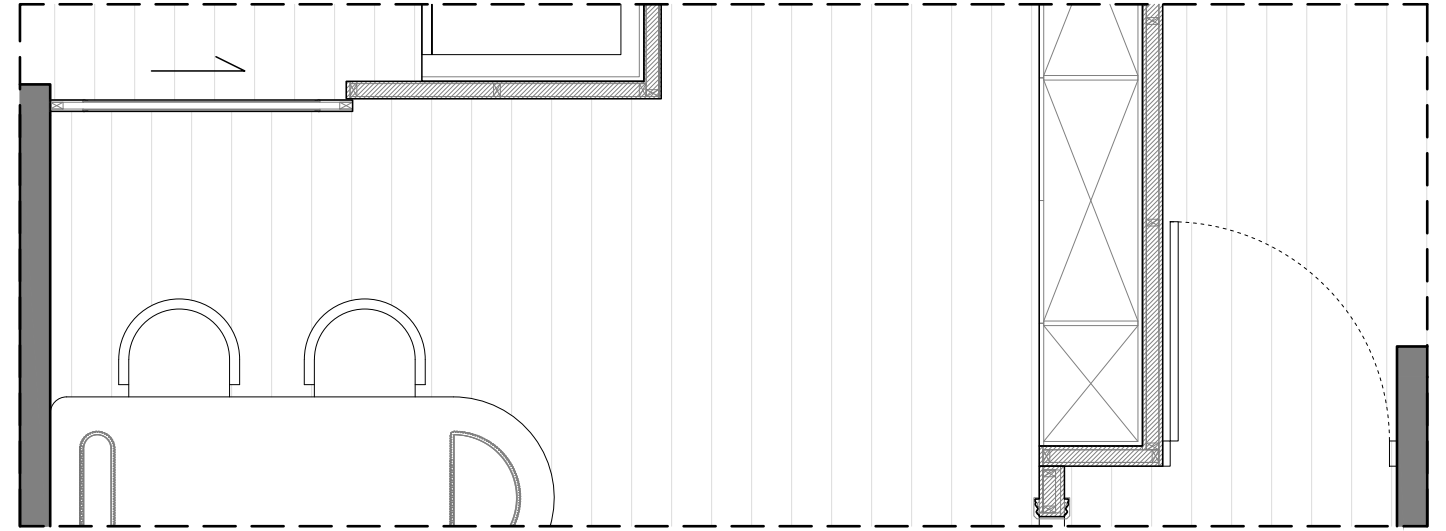
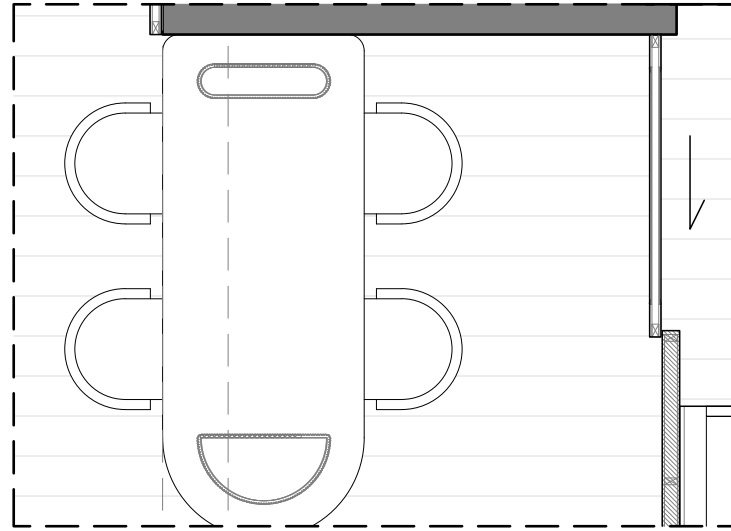

<立面C-2、D-2> (共1組) 飾花線板貨號與數量(1組)			
L1	HK-600	5	pcs.
	7M+4.4M=11.4M		
L2	HK-614	4	pcs.
	5.1M+3.6M=8.7M		
L3	HK-631D8	3	pcs.
	6.4M		
L4	HK-0101	2	pcs.
	4.7M		
L5	W-1407	3	pcs.
	1.2M+1.3M=2.5M		
01	HK-614G	4	pcs.

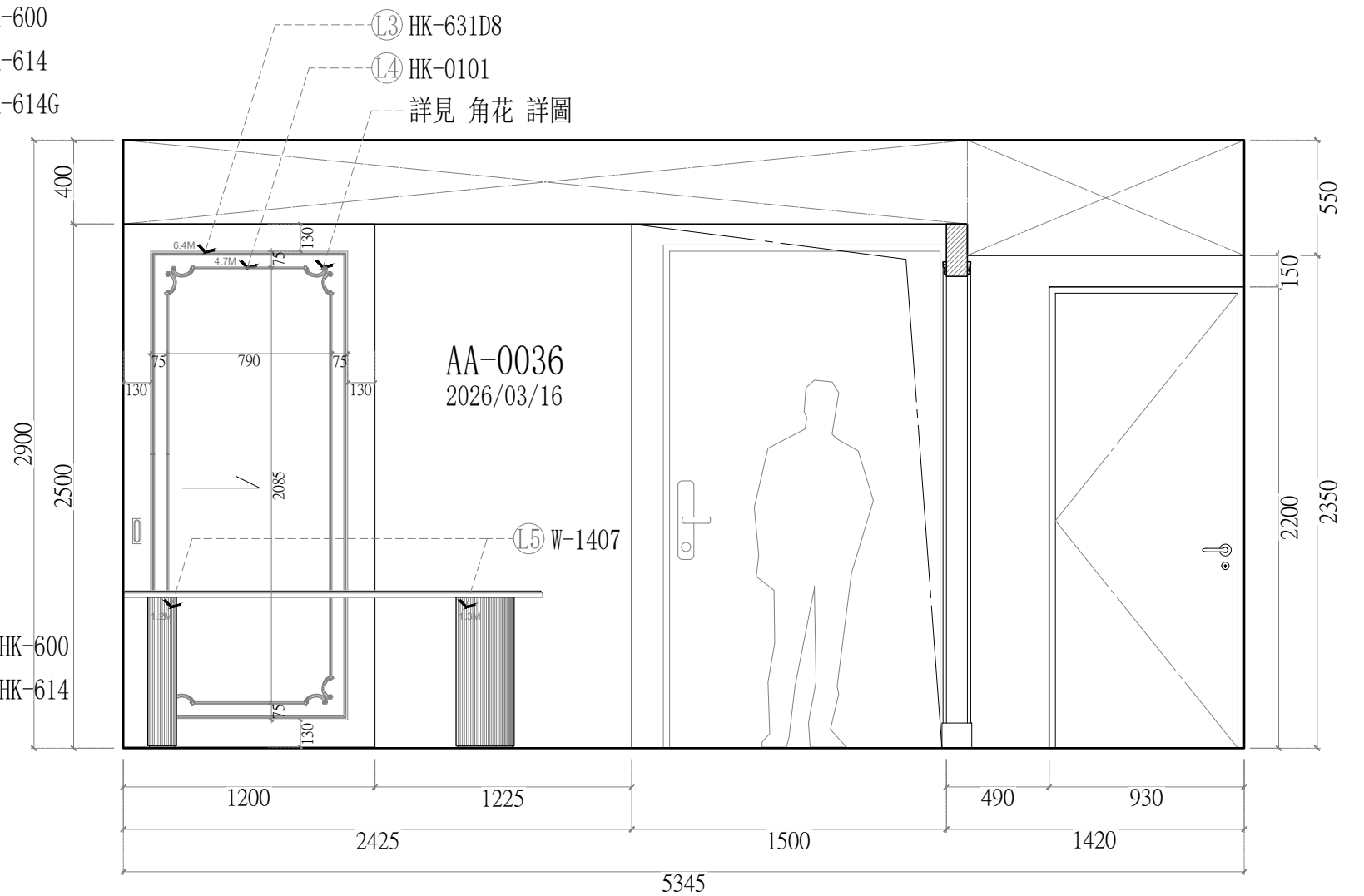

客廳 立面C-2配置圖



客廳 立面D-2配置圖

線板大樣圖	產品貨號表
	HK-620
	W-1403

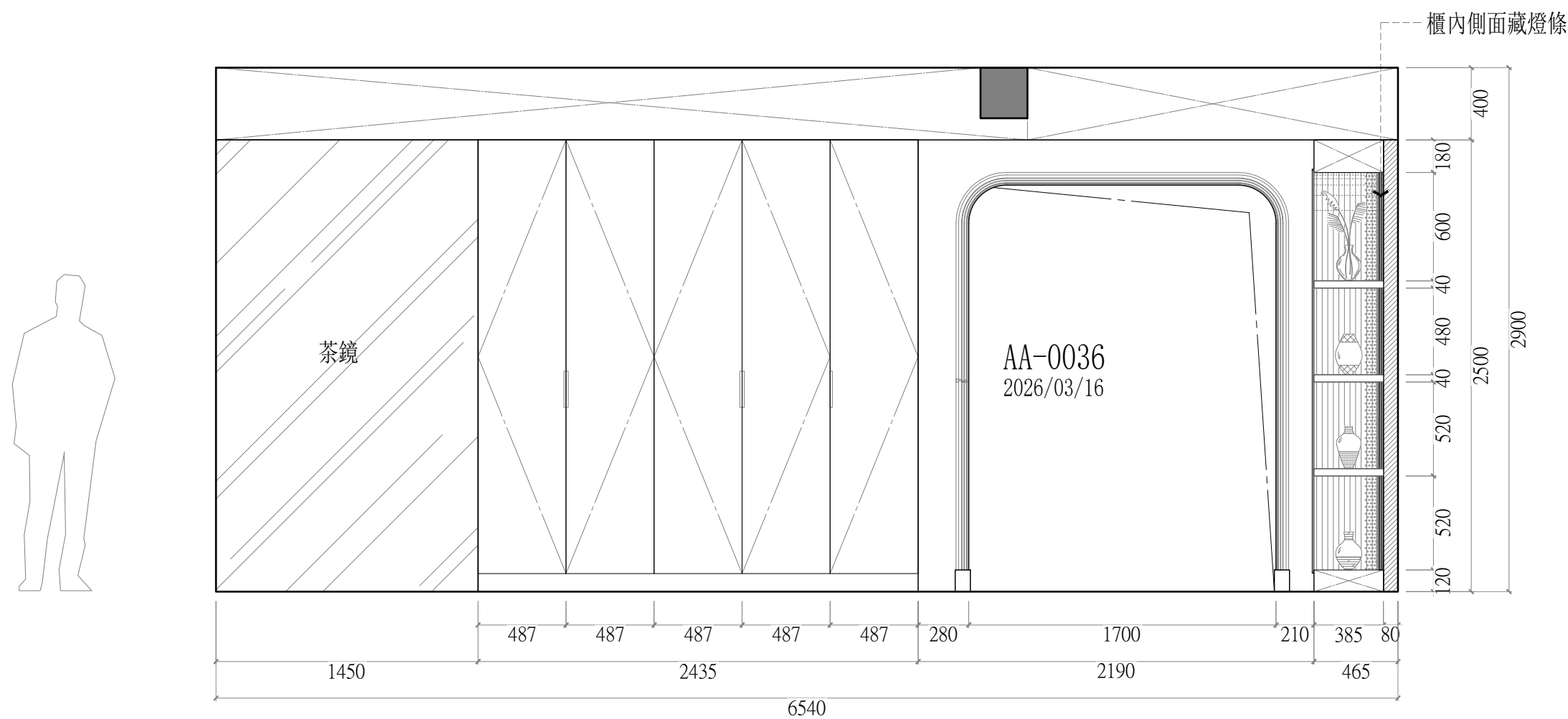
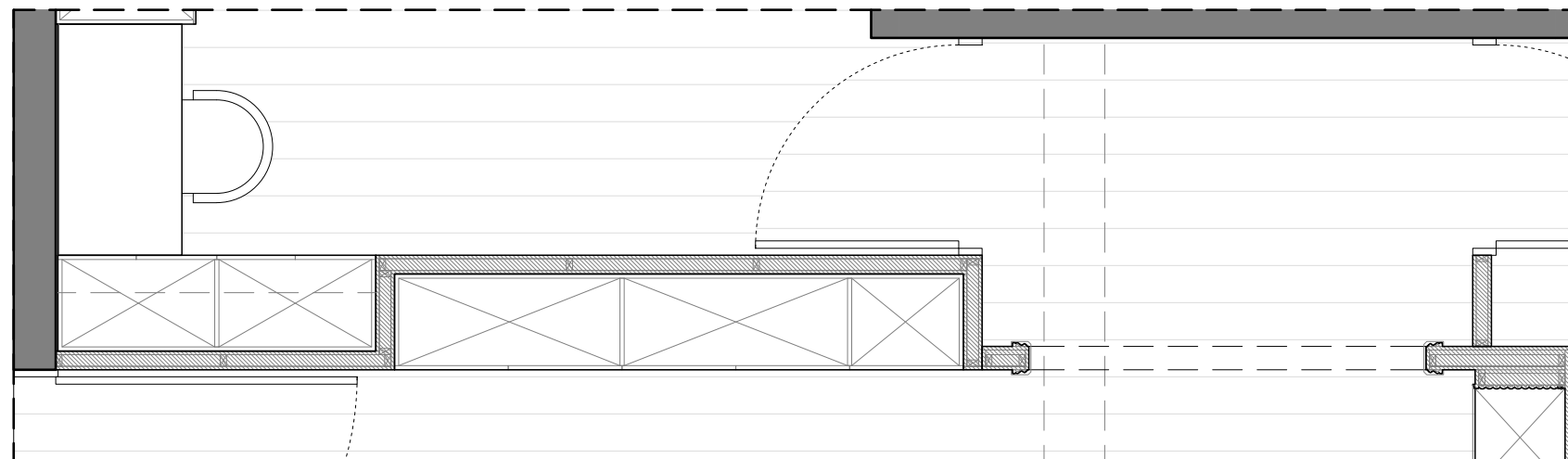

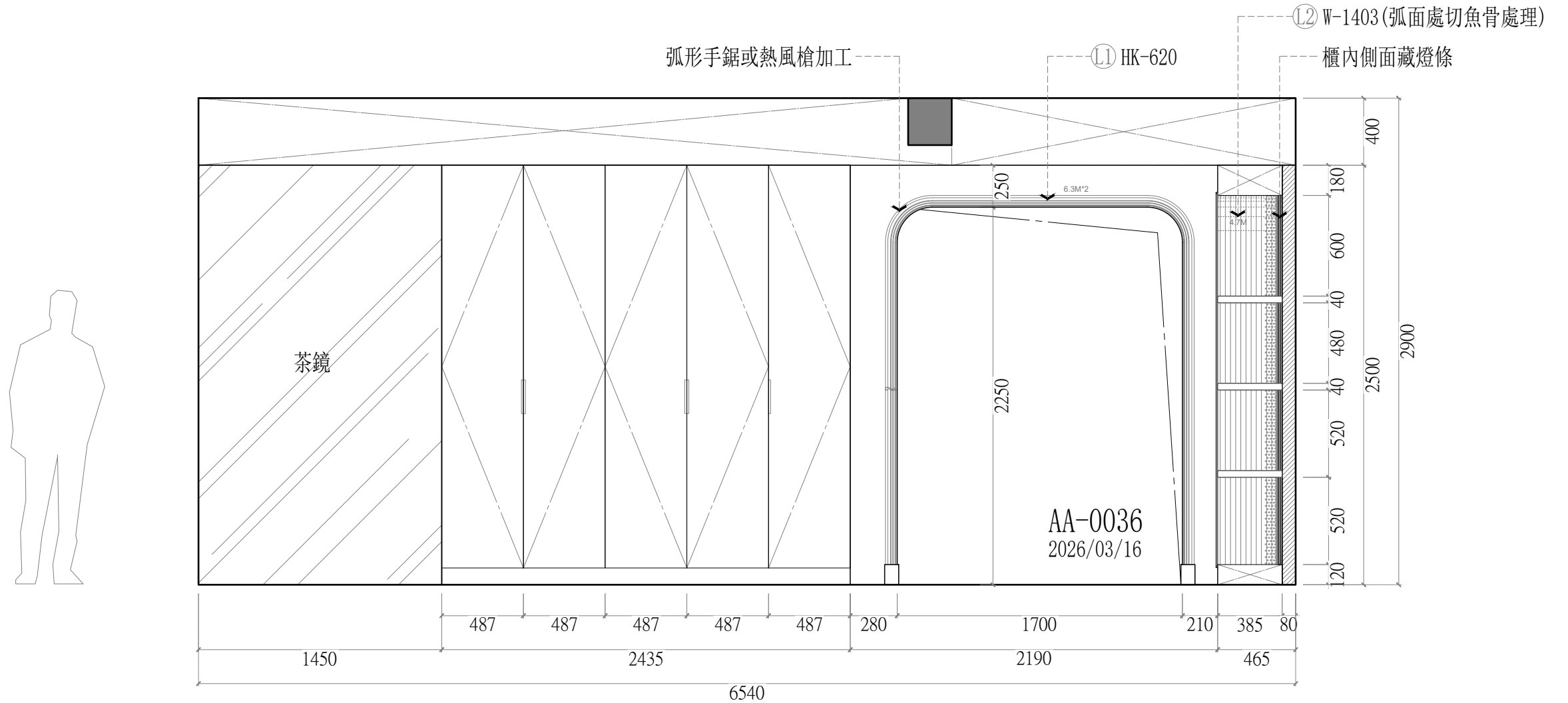
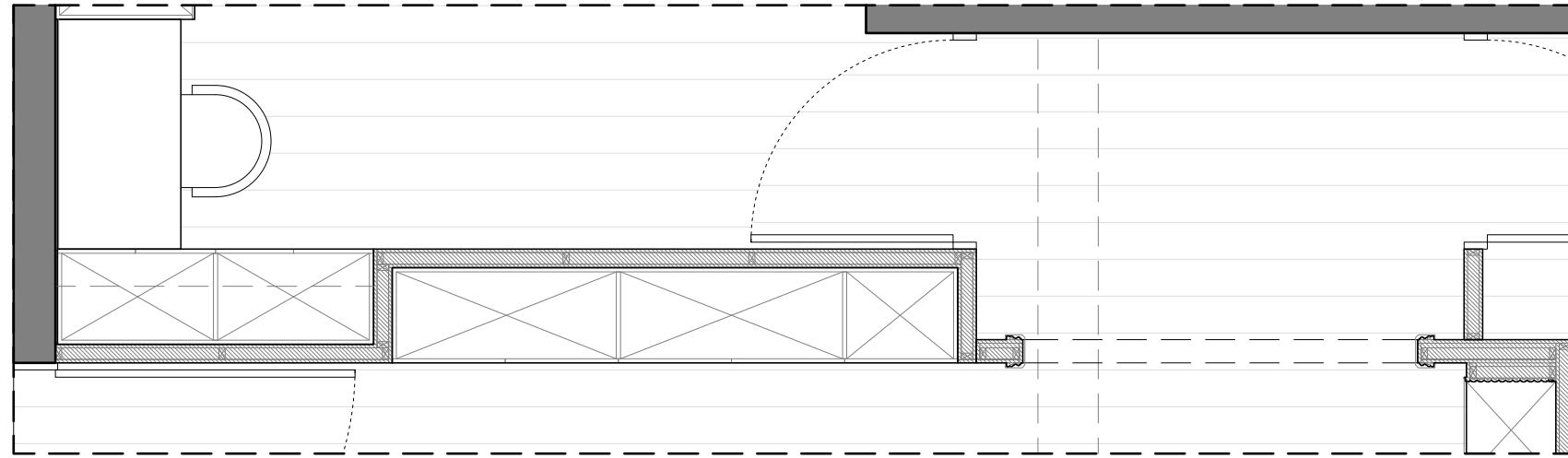

客廳 立面A-2配置圖

<立面A-2> (共1組) 飾花線板貨號與數量(1組)			
L1	HK-620	6	pcs.
	6.3M*2=12.6M		
L2	W-1403	2	pcs.
	4.7M		



客廳 立面A-2配置圖

線板大樣圖	產品貨號表
	HK-600
	HK-614

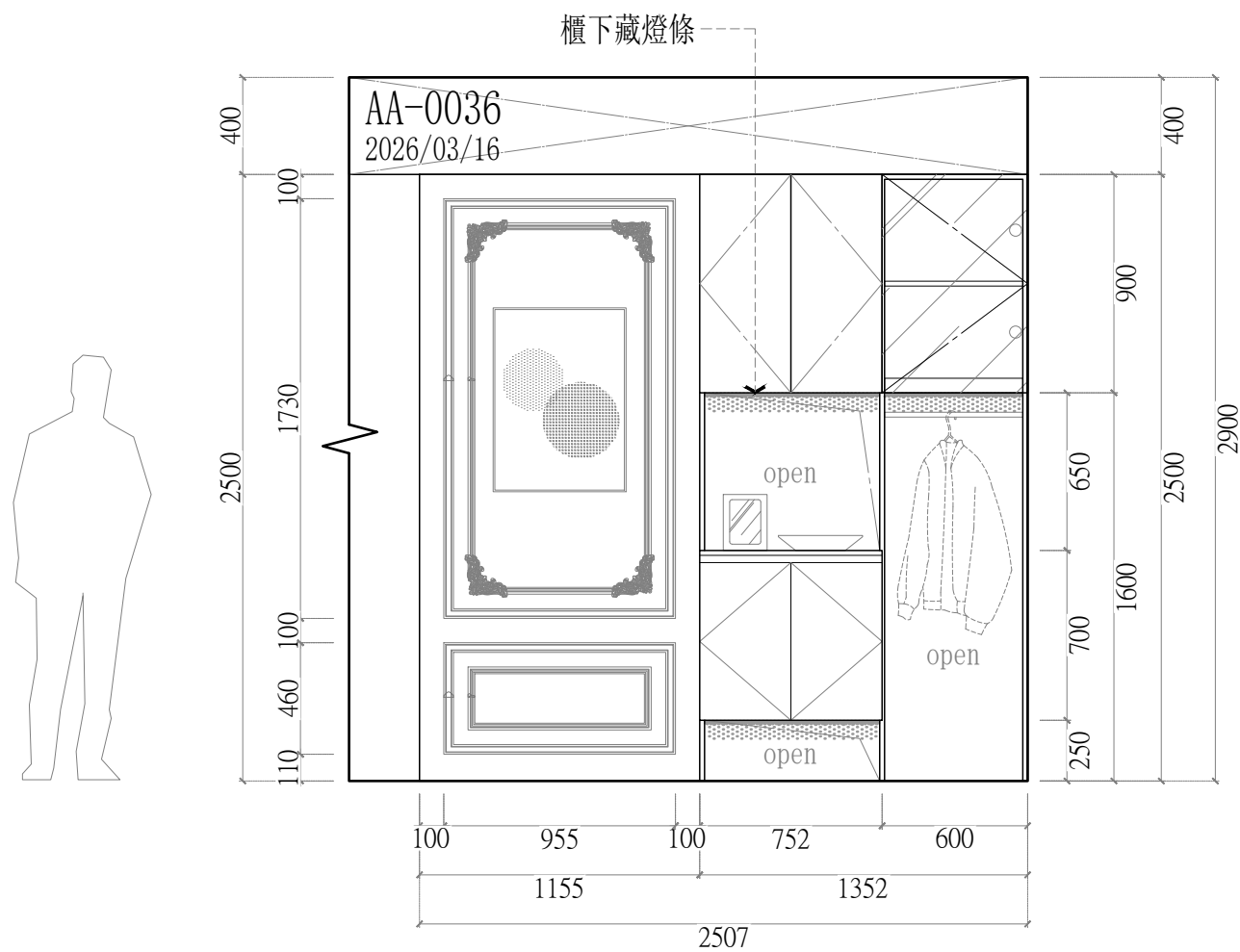
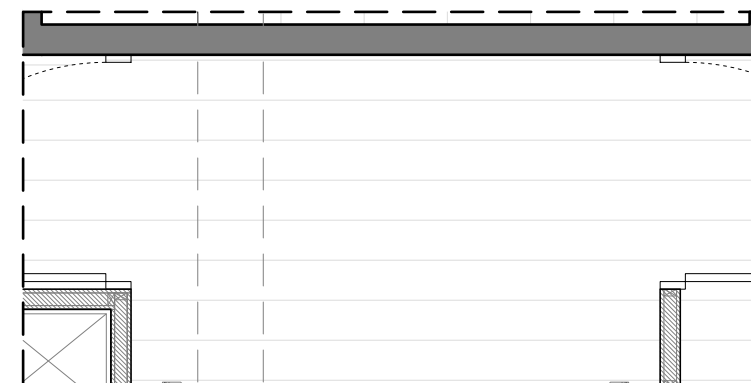
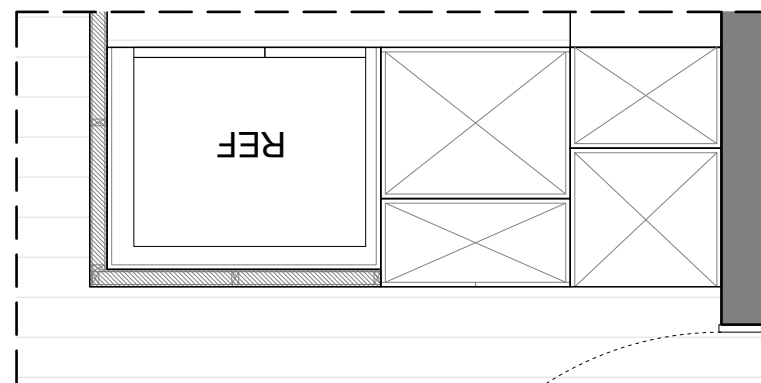

客廳 立面C-3配置圖

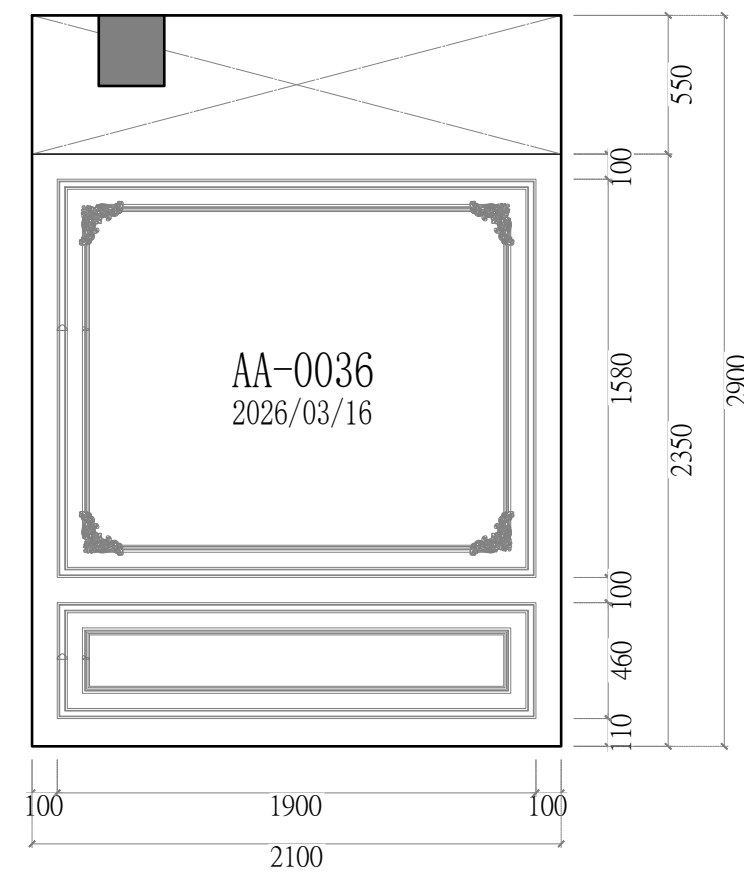

客廳 立面A-2-1配置圖

<立面A-2-1、C-3> (共1組) 飾花線板貨號與數量(1組)			
L1	HK-600	10	pcs.
	2.9M+5.4M+7M+4.8M=20.1M		
L2	HK-614	8	pcs.
	2.1M+3.5M+5.1M+4M=14.7M		
01	HK-614G	8	pcs.

